



COMPACT DESIGN
BIG PERFORMANCE

G2500

HD / X-TRA HD

EN



GIANT[®]
BY TOBROCO

WWW.TOBROCO-GIANT.COM



G2500

HD / X-TRA HD



DISTINCTIVE POWER

A mini shovel with sizeable performance and stage V engine. The G2500 HD is equipped with hydrostatic 4 wheel drive, 2 gears and 8 tons planetary axles. This ensures that it is comfortable to work with this articulated loader, especially because the G2500 HD comes with a luxury seat, double-acting function at the front and ROPS/FOPS, certified, safety roof as a standard.

Depending on the work that needs to be done, the G2500 HD can be configured entirely according to your wishes. In addition, TOBROCO-GIANT offers a wide range of attachments, with which the machine can be used all year round for all kinds of work.

TYPES	G2500 HD	G2500 X-TRA HD
Service weight ¹	2.400 kg	2.400 kg
Lifting capacity	1.750 kg	2.200 kg
Tipping load	2.050 kg	2.600 kg
Lifting height	2.964 mm	2.498 mm
Length without bucket	3.247 mm	3.316 mm
Width	1.100 mm	1.100 mm
Machine height	2.322 mm	2.322 mm

¹ Measured with standard version and earthbucket.

STRONG CHARACTERISTICS



- 1. WORKING COMFORTABLY** - A spacious comfortable working environment.
- 2. WORK SAFELY** - The cabin and safety roof are ROPS/FOPS certified on international standard.
- 3. COMPACT DESIGN** - The compact design of the G2500 HD makes it possible to work in tight spaces.
- 4. EASY SERVICE** - Maintenance on the G2500 is easy to perform because the maintenance points are easily accessible.
- 5. POWERFUL PERFORMANCE** - A reliable 4-cylinder, Kubota engine without DOC and DPF ensures powerful performance.
- 6. HYDRAULIC POSSIBILITIES** - The standard version with double-acting function at the front (mechanically operated) can easily be expanded with additional hydraulic functions and a tandem pump.
- 7. MANEUVERABILITY AND STABILITY** - The articulated pendulum system ensures maneuverability and stability.
- 8. PRODUCTIVITY** - Hydrostatic 4-wheel drive, 2 gears and 8 tons axles with planetary final drive.
- 9. SPEED** - 0-10 km/h, 0-20 km/h (2 gears).
- 10. CHOOSE THE MACHINE FOR YOUR WORK** - Depending on the work, you can opt for a standard or X-TRA version with associated options.

TOP PERFORMANCE



“Our GIANT machine is a real multi-tasker, it can level, load and move materials very quickly around the site.” - Christiaan Paul, Fresh Approach

POWERFUL ENGINE

To ensure proper performance and fuel efficiency, the G2500 is powered by a reliable 19 kW / 26 HP diesel engine from Kubota without DOC and DPF, meeting the latest EU stage V emission standards.

STRONG WORKING HYDRAULICS

The hydraulic system of the G2500 models is controlled directly via the joystick and with 40 ltr/min (210 bar) is more than sufficient to drive a large number of attachments. If the work demands it, the work hydraulics can be further expanded with additional double-acting functions and an electrically switchable tandem pump.



COMPACT DESIGN



STABILITY AND MANEUVERABILITY

The articulated pendulum system gives the G2500 a lot of stability and manoeuvrability. The system ensures that all four wheels always remain on the ground, even when working on uneven terrain. This not only makes work safer, but also ensures sufficient traction at all times.

The compact design of the G2500 HD makes it possible to work in tight spaces. The limited height of 232 cm also offers the possibility to carry out work indoors.

Optionally, the models can be equipped by a ROPS / FOPS certified folding safety roof. This lowers the headroom even more with 34 cm. The G2500 HD has a lifting height of 2.96 meters and a tipping load of 2,050 kg. The X-TRA model has a lifting height of 2.49 meters and a tipping load of 2,600 kg.

“Our work involves a lot of rough terrain work, the GIANT machine is very suitable for that, especially with the extensive range of attachments available. We hope to invest in another GIANT in the very near future.”

- Demesne Contracts, Seaforde in Co Down

SAFETY AND COMFORT



The machines are equipped with a safety roof as standard and can optionally be expanded to a full-option cabin. The G2500's spacious cab is easy to access and designed according to user's needs: the steering column is adjustable in depth and equipped with a dashboard where all necessary information can be easily read. The mechanically suspended seat is luxuriously designed and easy to adjust for good posture. While using the multifunction joystick, the operator can rest his arm on an ergonomically shaped armrest. Important buttons are within easy reach on and next to the joystick.



360° all-round visibility from the cabin

The G2500 machines have been rigorously tested for safety by an independent body and internationally certified for ROPS/FOPS protection. The operator's central position and the use of narrow stiles and a skylight provide 360-degree visibility all around and on the implement. This ensures that work can be performed efficiently and accurately.



ELECTRONIC CONTROL

Information about the engine temperature and other indicators can be read from the dashboard so that the driver can always see these important data during work.

ATTACHMENTS

500+ attachments

Our attachments are developed entirely in-house so that they deliver the best results when working on our machines. TOBROCO-GIANT offers more than 500 different attachments so your machine can be used all year long. By choosing the right attachment it is possible to adjust your GIANT to working conditions for agricultural purposes, construction, material handling, private use and many other areas of application. Get every job done with just one machine!

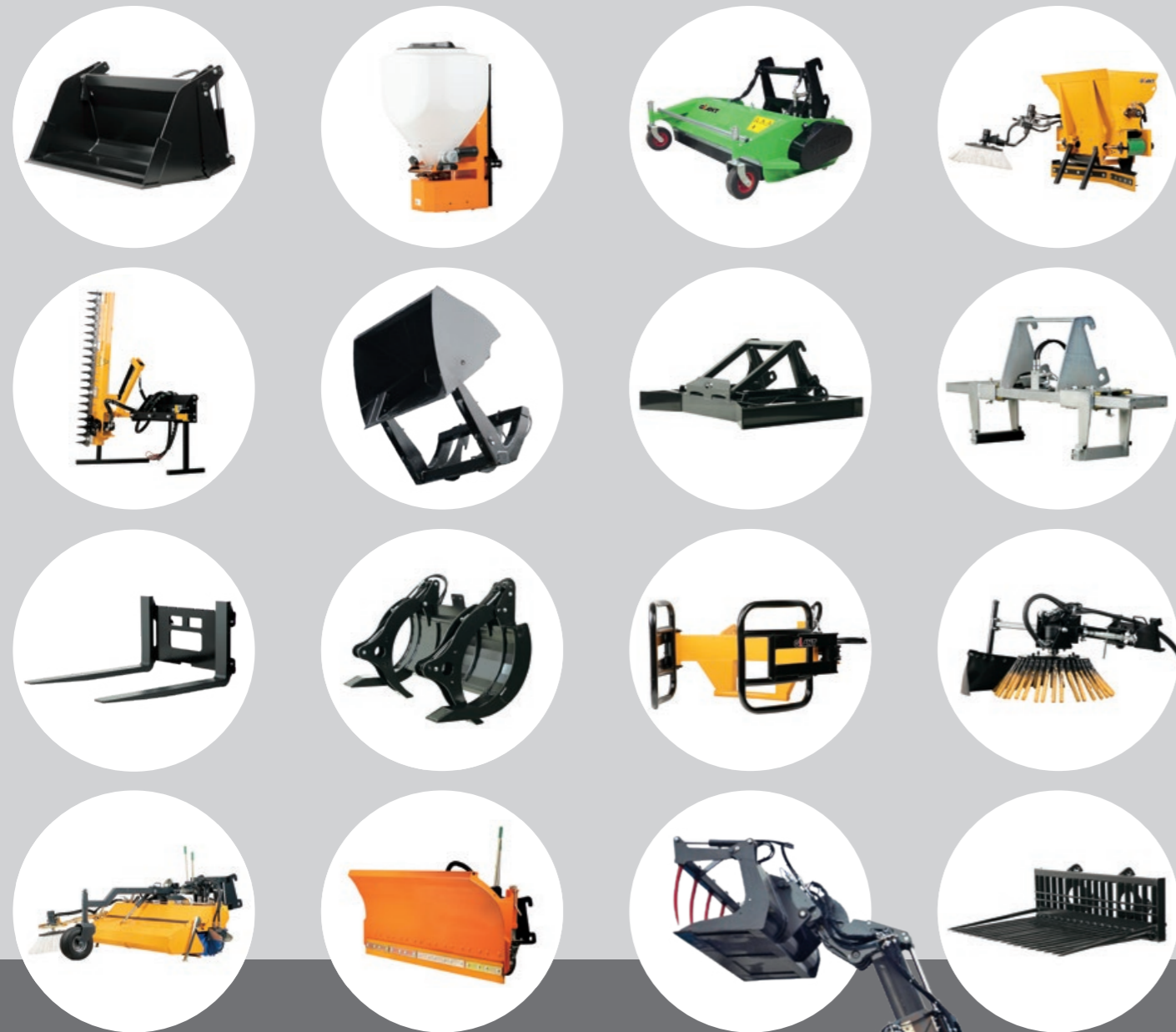

HYDRAULIC QUICK COUPLER

The G2500 models are standard equipped with a hydraulic quick coupler as a standard. This makes it possible to change attachments safely and within seconds.

MOUNTING SYSTEMS

TOBROCO-GIANT offers a wide range of mounting systems, enabling you to use the attachment that you already have.



SECTORS

One machine for every job



INFRASTRUCTURE



AGRICULTURAL



CONSTRUCTION & DEMOLITION



EQUINE INDUSTRY



FORESTRY



GOVERNMENT & MUNICIPALITIES



MATERIAL HANDLING



NURSERIES

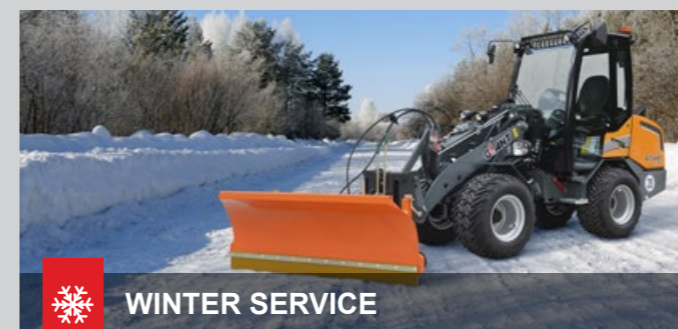

WINTER SERVICE



LANDSCAPING & GROUND CARE

SPECIFICATIONS

TECHNICAL DATA

TYPE	G2500 HD	G2500 X-TRA HD
Service weight ¹	2.400 kg	2.400 kg
Lifting capacity	1.750 kg	2.200 kg
Tipping load ²	2.050 kg	2.600 kg

DIMENSIONS AND SPEED

Lifting height ²	2.964 mm	2.498 mm
Length without bucket	3.247 mm	3.316 mm
Machine height ³	2.322 mm	
Width on standard tyres	1.100 mm	
Standard tyres	11.5/80-15.3 AS	
Travel speed	0-10 km/h 0-20 km/h	

ENGINE

	Kubota D1505 (STAGE V)	
Cylinders	4	
Engine power	26 HP / 19 kW	
Type	Diesel	
Fuel tank capacity	47 l	30 l
Oil capacity	48,5 l	48,5 l

POWERTRAIN

Type	Hydrostatic 4 wheel drive
Transmission	Automotive control
Differential	Limited slip on both axles
Final drive	8 tons planetary axles
Pulling force	18.000 N
Driving hydraulics	65 ltr/min (360 bar)
Working hydraulics	40 ltr/min (210 bar)
Parking brake	Drum brakes

STANDARD MACHINE FEATURES

TYPE	G2500 HD	G2500 X-TRA HD
GIANT Standard quick change system	Std	Std
ROPS/FOPS safety roof incl. safety doors (L+R)	Std	Std
Mechanically suspended seat incl. safety belt and armrest	Std	Std
1x double acting hydraulic function on lifting arm, mechanical	Std	Std
Floating position on lifting cylinder(s)	Std	Std
Hydraulic servicebrake on 4 wheels	Std	Std
Working light (halogen) front, on lifting arm	Std	Std
Main switch	Std	Std
Shunt coupling	Std	Std
Counterweight integrated into the bumper	Std	Std
Cyclone filter	Std	Std
Oil cooler	Std	Std

¹ Measured with earthbucket

² Measured with hinge point in straight position on standard tyres

³ Measured on standard tyres with safety roof

MEASUREMENTS

	UNIT	G2500 HD	G2500 X-TRA HD
A Wheelbase	mm	1.643	1.695
B Total length	mm	3.247	3.316
C Length with bucket	mm	4.015	4.085
D Length 3 point hitch	mm	540	540
E 3 point hitch in lowest position	mm	253	253
F 3 point hitch in highest position	mm	652	652
G Seat height	mm	1.341	1.341
H Max. height with safety roof	mm	2.322	2.322
I Max. height with cabin	mm	2.345	2.345
J Height front frame	mm	1.731	1.492
K Max. dumping height	mm	2.144	1.735
L Lifting height	mm	2.964	2.498
M Height with bucket	mm	3.532	3.070
N Rollback angle on the ground	degrees	43	42
O Rollback angle at max. lift height	degrees	45	47
P Max. angle for bucket emptying	degrees	43	37
Q Drive-up angle	degrees	28	28
R Outer size of tyres	ø mm	850	850
1A Turning radius with bucket	mm	2.972	3.045
1B Turning radius on outer edge	mm	2.560	2.623
1C Inner turning radius	mm	1.460	1.523
1D Width on standard tyres	mm	1.100	1.100

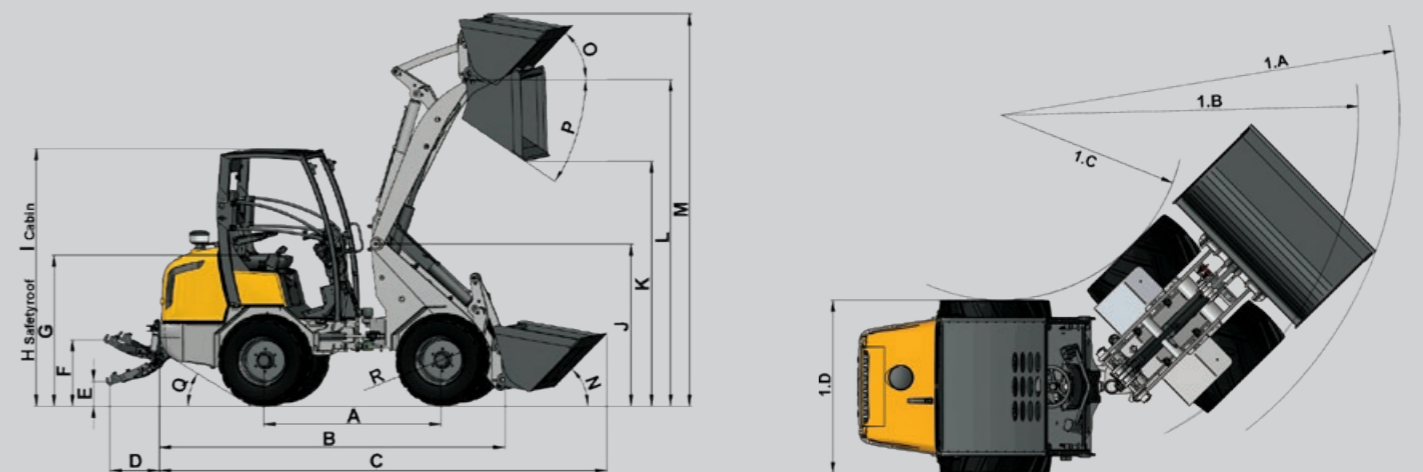

TIPPING LOADS

	G2500 HD	G2500 X-TRA HD
S	2.200 kg	2.700 kg
T	1.620 kg	2.000 kg
U	1.200 kg	1.400 kg
V	900 kg	1.000 kg
W	2.650 kg	2.800 kg
X	1.700 kg	1.800 kg
Y	1.250 kg	1.380 kg



Measured with GIANT hitch, The above values may deviate for other types of hitches.

AVAILABLE OPTIONS

	G2500	G2500 X-TRA HD
SAFETY ROOF / CABIN		
ROPS/FOPS safety roof deluxe	0	0
Glass doors, set (L+R)	0	0
ROPS/FOPS foldable safety roof incl. safety roof (clearance height with folded safety roof: 1.980 mm)	0	0
ROPS/FOPS foldable safety roof deluxe incl. safety doors, 2 side mirrors, 2 working lights (halogen) front and 2 rear	0	0
ROPS/FOPS Cabin incl. heating, radio and speakers, 2 side mirrors, 2 working lights (halogen) front and 2 rear	0	0
FM/AM radio and speakers	0	0
DAB+ radio with bluetooth and USB 2.0	0	0
Cabin mat	0	0
Mechanically suspended seat with seat heating incl. safety belt and armrest	0	0
Air suspended seat incl. safety belt and armrest	0	0
Air suspended seat with seat heating incl. safety belt and armrest	0	0
Side mirrors (L+R)	0	0
ROPS roll bar conversion set	0	0
HYDRAULIC CONNECTIONS ON LIFTING ARM		
Transport securing device	0	0
Hose rupture protection on lift and top cylinder	0	0
Hose rupture protection on lift and top cylinder + floating position + transport securing device	0	0
1x extra double acting hydraulic function, mechanical	0	0
1x extra double acting hydraulic function, electric/hydraulic in joystick	0	0
2x extra double acting hydraulic function, electric/hydraulic in joystick	0	0
Electrically switchable tandem pump: 1x extra single acting hydraulic function, 37 ltr/min + free hydraulic return	0	0
Single-side or double-side hydraulic hold on additional function	0	0
Leak oil connection	0	0
Free hydraulic return	0	0
HYDRAULIC CONNECTIONS AT THE BACK OF THE MACHINE		
1x extra double acting hydraulic function, mechanical	0	0
1x extra double acting hydraulic function, electric/hydraulic in joystick	0	0
Electrically switchable tandem pump: 1x extra single acting hydraulic function, 37 ltr/min + free hydraulic return	0	0
Leak oil connection	0	0
Free hydraulic return	0	0
Three point lifting mechanism (Cat. 1)	0	0
ELECTRICAL / LIGHTING		
Switched 12 Volt socket, 3-pin (front and/or back)	0	0
13-pin trailer socket to the back	0	0
Working light (halogen or LED) to the front	0	0
Working light (halogen or LED) to the front of safety roof (max. 2)	0	0
Working light (halogen or LED) behind the seat (max. 2)	0	0
Flashing/warning light (halogen or LED) mounted on safety roof (max. 2)	0	0
2x flashers (LED) front + 2x flashers (LED) rear	0	0
Traffic lights (halogen or LED)	0	0
License plate holder with illumination	0	0
OTHER OPTIONS		
Machine sprayed in RAL company colour	0	0
Hand throttle	0	0
Hand inching	0	0
Pro-inching	0	0
STABILO system (patented)	0	0
Back-up alarm (acoustic)	0	0
Jump start	0	0
Mudguard wideners	0	0
Towing hook	0	0
Towing hook + tow ball	0	0
Counterweight (125 kg) under the machine	0	0
Different hitch	0	0
Boom suspension	0	0
Parallel indicator on tilt cylinder	0	0
Kit engine heater 220V	0	0
Document box	0	0
Panolin HLP Synth 46 biodegradable hydraulic fluid	0	0
Road specification (ask your dealer for details)	0	0

MAINTENANCE & SERVICE

MAINTENANCE



Performing maintenance to the G2500 is no problem at all because the service points are easy to reach. Filters, hydraulic system and engine can be freely accessed via the easy-to-open bonnet, tilting cab or other service panels. This ensures that daily checks and maintenance can be carried out quickly and in a safe manner.

GENUINE GIANT PARTS



The usage of genuine GIANT parts ensures reliable, efficient and safe operation of your machine. We only use the best quality components and test them severely before we introduce a new model. All these parts are vital for the best possible performance and minimising downtime. Keeping your GIANT 100% original saves money for the owner because of reduced maintenance costs and results in a higher resale value once the machine is resold.

SERVICE & SUPPORT

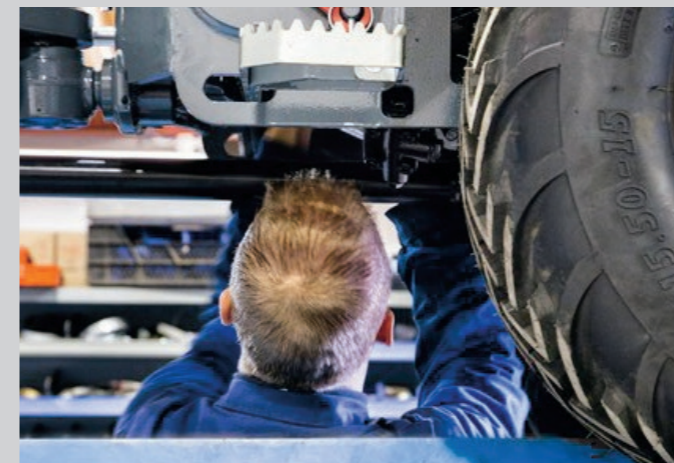

At TOBROCO-GIANT we offer support, service and high quality parts to protect the investment that you have made in GIANT machinery. Together with our dealers we are available to make sure that your machine performs in the best possible way. This increases your productivity and will result in an even better return on your investment.

TRAINING



At TOBROCO-GIANT we know all the details about our machines. That is why we offer an extensive training program to our dealers. Not only on the newest features or attachments, but also on how to service a machine to the highest standards.



Quality - Growth - Innovation - Integrity -
Customer Oriented - Enterprising

*“Developed in
The Netherlands, built for
the world”*



Within 25 years, TOBROCO-GIANT has grown into a global player in compact machines with one of the broadest portfolios in the industry. The wide range of implements ensures that all work can be carried out with one machine. This means that GIANT machines can be used all year round for all kinds of work.

In a modern factory in the Netherlands, machines and attachments are developed and produced in-house. By using the most modern technology, ensuring continuous innovation and applying the best components from Kubota, Bosch Rexroth and Comer, GIANT machines and attachments are produced with the greatest care and quality.

Every day, the team of more than 500 employees in the Netherlands, Hungary and America focuses with passion and enthusiasm on complete customer satisfaction.

THE FUTURE IS ELECTRIC

The demand for compact electrical equipment is an unstoppable trend. With Jungheinrich, TOBROCO-GIANT has found a global and reliable partner with expertise when it comes to developing electrical machines. Everything is aimed at developing an electric version of each GIANT along to the diesel version in the long term.

DEALER NETWORK

With a large network of dedicated dealers we like to be close to our customers to provide the machines, service and parts that you demand. All dealers are supported by a team of experts from the head office of TOBROCO-GIANT in Oisterwijk, The Netherlands.

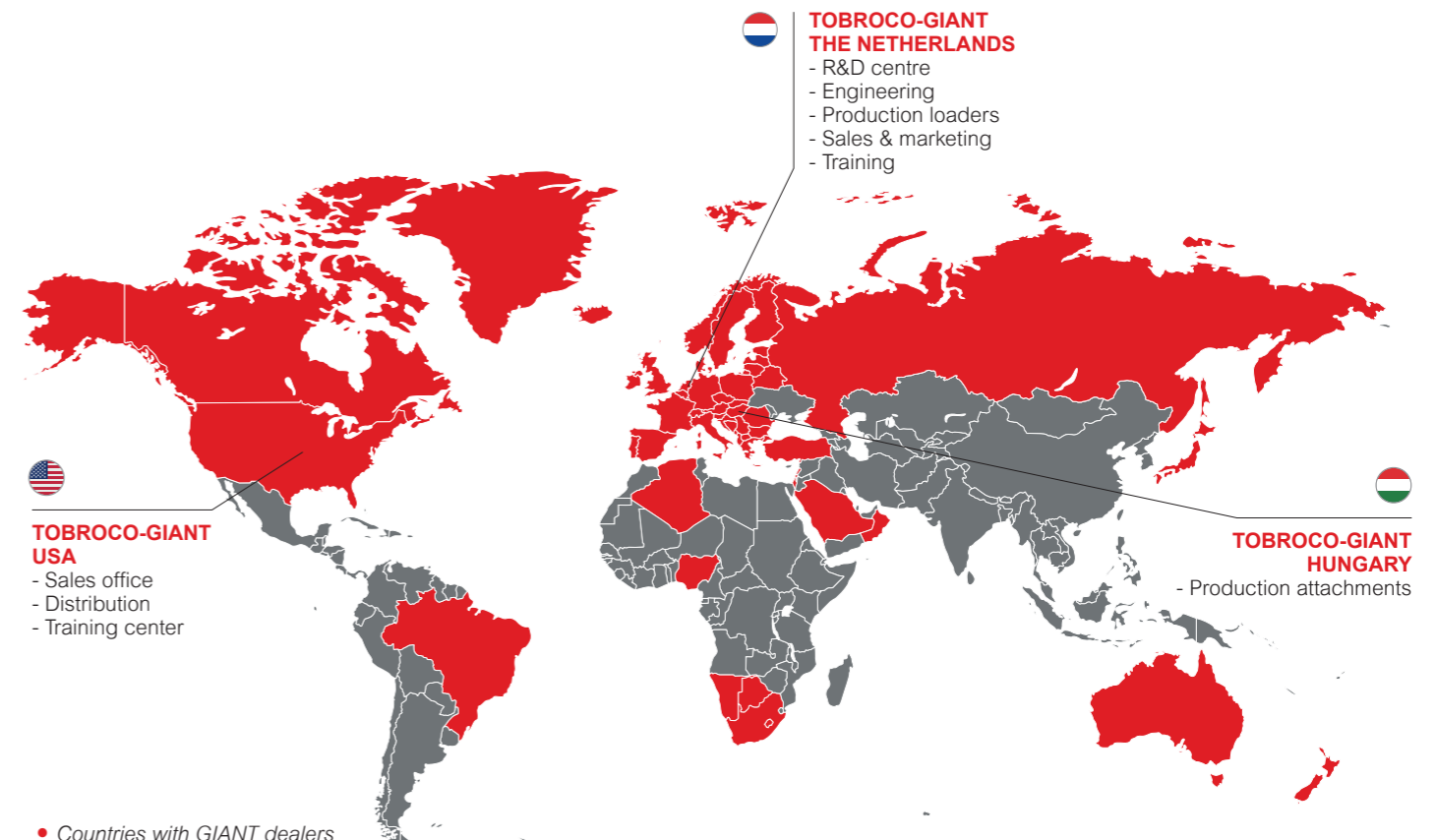

ALL MODELS

TOBROCO-GIANT has been manufacturing high-quality GIANT machines and attachments since 1996 when we opened our first factory in The Netherlands. Today, TOBROCO-GIANT offers one of the broadest product portfolios in the business with 35 different models sold in 60 countries. In addition to machines with motors from 20 hp to 76 hp, TOBROCO-GIANT also supplies electrical machines and a complete line of compaction machines. TOBROCO-GIANT grows into a full-liner in compact and durable equipment.



SK212G
SK202D
SK252D



G1100 (TELE)
G1200 (TELE)



G1500 (X-TRA)



G2200E (X-TRA) 



G2300 (X-TRA) HD



G2500 (X-TRA) HD



G2700 (X-TRA) HD
G2700 (X-TRA) HD+
G2700E (X-TRA) 



G3500 (X-TRA / TELE)



G5000 (X-TRA / TELE)



GT5048



VIBRATORY PLATES
E-VIBRATORY PLATES 



VIBRATORY RAMMERS
E-VIBRATORY RAMMERS 



REVERSIBLE VIBRATORY PLATES
E-REVERSIBLE VIBRATORY PLATES 

 Electric



GIANT[®]
BY TOBROCO

TOBROCO-GIANT

Sprendlingenstraat 57, 5061 KM Oisterwijk (The Netherlands)

Tel.: +31 (0)13-5211212 | Fax: +31 (0)13-5234045

Internet: www.tobroco-giant.com | E-Mail: info@tobroco-giant.com

Article number and version number:
P00132500EN V122



CONNECT WITH US

All technical data in this brochure refer to under Central European operating conditions tested series models and describe the standard functions. Specifications and their modes of operation, as well as accessories, depend on the model and the options of the product, as well as country-specific regulations in the country of sale. Images may show non-listed or non-standard available products. The descriptions, illustrations, weights and technical data are not binding and are in accordance with the state of the art at the time of going to press. Changes in the design, equipment, optics and technology are due to the continuous development of its products without prior notice. Do you need special functions which are only available through the use of additional components and / or under special circumstances, please contact us! We will be happy to answer your questions and let you know whether and under what conditions regarding the product and the environmental conditions special functions are realizable. When doubts about the capacity or the performance of our products under special circumstances, we recommend to perform under controlled conditions. Testing activities despite the utmost care, we cannot rule out deviations from illustrations or dimensions, calculation errors, misprints or omissions in this brochure. We therefore accept no liability for the correctness and completeness of the information contained in this brochure. As part of our General Terms and Conditions, we guarantee the proper functioning of our products. Furthermore Linear guarantees we provide in principle. A further liability than outlined in our Terms and Conditions is excluded.

